



# Air-Farm User Manual

CO2 / Temperature / Humidity Transmitter

---

## Features

- CO2, Temperature and Humidity measurement
- Three high sensitivity sensors
- RS485(MODBUS) Communication
- Analog Voltage and 4-20mA Current Output
- Alarm function for Air Status Warning
- Compact waterproof box of size 120mm x 80mm x 55mm



Model : TT200

## Application

Air-Farm (Model: TT200) can measure the Air Status such as: CO2, Temperature and Humidity values.

This model has three sensitive sensors, which makes it an optimum choice for installation in Factories or Greenhouses.

This interface supports RS485 communication and two analog output types (i.e, Voltage and Current).

So, this model can be connected to other systems. Maximum 100 devices are possible to be connected on RS485 bus, Each of these device can have 0-5V, 4-20mA Output.

This model has Active Low Output (NPN driven Output) for the systems such as Relays, LEDs, etc, for CO2 quality warning.

**Table 1. General Specifications**

Parameter	Min	Typ	Max	Unit	Notes
Power Supply	8	12	36	V	
Current Consumption	0.04	0.05	0.15	A	Test with Vin = 12V Supply Voltage
Operating Temperature	-10	-	50	°C	

**Table 2. Sensors Specifications**

Parameter	Min	Typ	Max	Unit	Notes
CO2 Measuring Range	0	-	10000	ppm	
Accuracy (CO2)	+/-30Ppm +/-5%				Above 0 °C
	+/-50ppm +/-7%				Below 0 °C
Temperature Measuring Range	-10	-	50	°C	
Accuracy (Temperature)	-0.4	-	+0.4	°C	
Humidity Measuring Range	0	-	80	%	
Accuracy (Humidity)	-4	-	4	%	

**Table 3. Interface Specifications**

Parameter	Min	Typ	Max	Unit	Notes
RS485 Recommended Request Time	500	1000	-	ms	
Analog Output Range	0	-	5	V	
4-20mA Current Output Range	4	-	20	mA	
Response Time (for Analog and Current Output)	1.7	2	-	s	
Alarm 'On' State (NPN Out)	-	2000	-	ppm	Alarm will be triggered

## RS485 Interface

The TT200 communicates with other devices over RS485 bus. MODBUS follows RS485 communication standard. See, Table 4, for configuration of RS485 communication.

**Table 4. Communication Configuration**

<b>Baud rate</b>	9600 bps
<b>Stop Bits</b>	1 bit
<b>Parity Check</b>	None
<b>Data Length</b>	8 bits

The details about request and response protocols are given in, Table 5. And this protocol is followed by RTU (Remote Terminal Unit). Description of MODBUS Protocol is given in, Table 6.

**Table 5. MODBUS Protocol**

<b>No. of Bytes</b>	1	1	2	2	2
<b>Tx</b>	Slave ID	Function Code	Starting Address	Request Quantity	CRC
<b>No. of Bytes</b>	1	1	1	n	2
<b>Rx</b>	Slave ID	Function Code	Data Length	Data[n]	CRC

**Table 6. MODBUS Protocol Byte Description**

Name	Bytes	Description
Slave ID	1	Set Device ID, through a rotary switch.
Function Code	1	Reading and Writing Request Code.
Starting Address	2	Starting address of data bytes.
Request Quantity	2	Number of sensors to be loaded with data.
Data Length	1	Number of data bytes.
Data[n]	n	Number of data bytes (n), sent by sensor. (Each device sends 2 data bytes)
CRC	2	Error checking according to CRC16 standard.

See Picture1, This rotary switch is for configuration of RS485 Slaves' Device ID. The left switch is for tens digit and right switch is for ones digit of decimal Device ID. So, User can easily configure Slaves' Device ID (a decimal number).

For example, If left switch is set at "3" and right switch is set at "1", then, RS485 Slave ID will be "31", which is equivalent to 0x1F (in hexadecimal notation).

**Picture 1. Rotary Switch**



List of functions is given in Table 7 and List of TRUEYES functions is given in Table 8 and address of each sensor is given in Table 9.

**Table 7. Function Code Table**

Function Description	Function Code
Read Holding Registers	0x03

**Table 9. Sensor Address Table**

Sub Device	Starting Address
CO2	0x0065
Temperature	0x0066
Humidity	0x0067
Slave (This Transmitter)	0x006B

**Table 8. TRUEYES Function Code Table**

Function Description	Function Code
Read Serial Number	0x50
Read Firmware Version	0x51
Request Manual Calibration	0x70
Read Manual Calibration State	0x71

This is an example of serial communication protocol.  
There is an example of CRC calculation for serial communication, on the page 9.

**Example 1. Read Holding Registers**

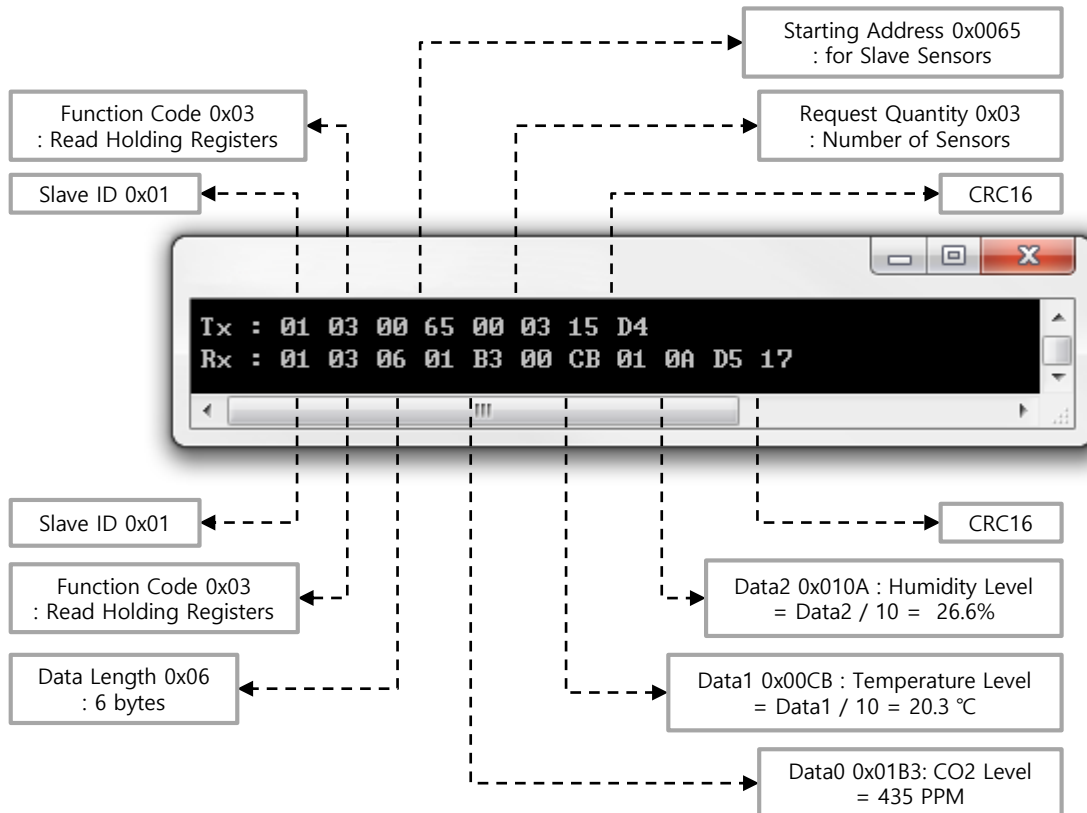

This is an example to read a Serial number of Air-Farm.

Example 2. Read Serial Number

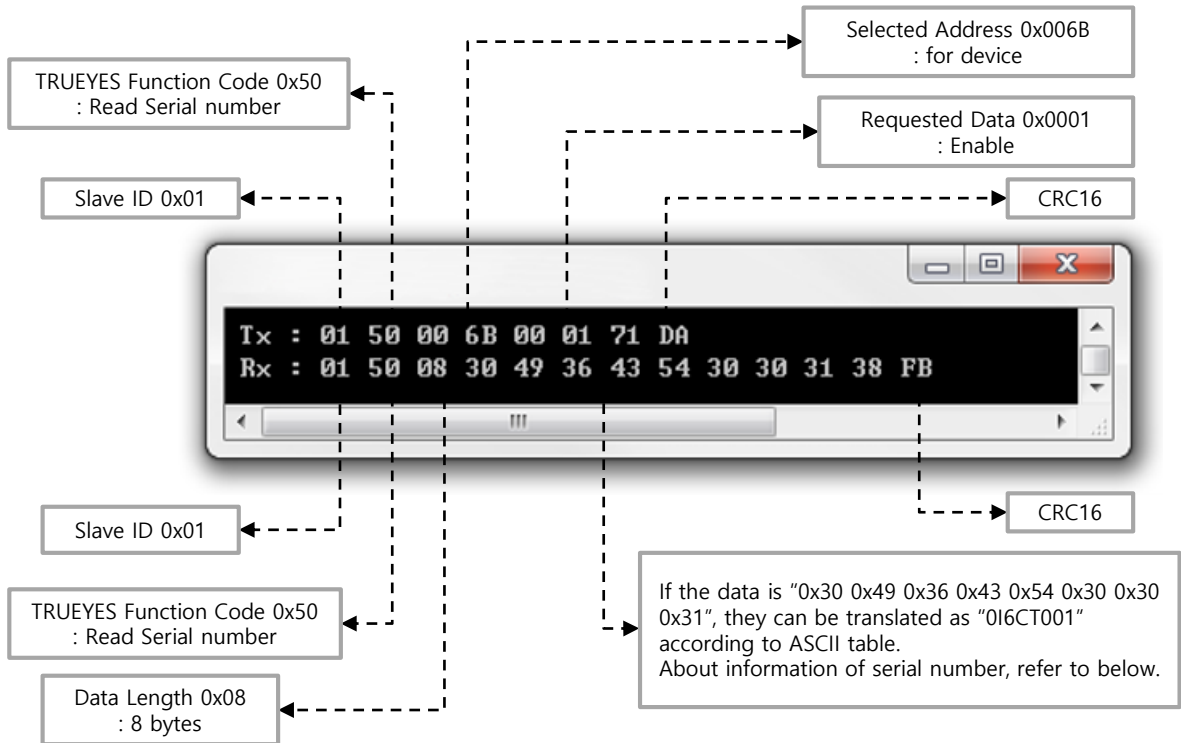
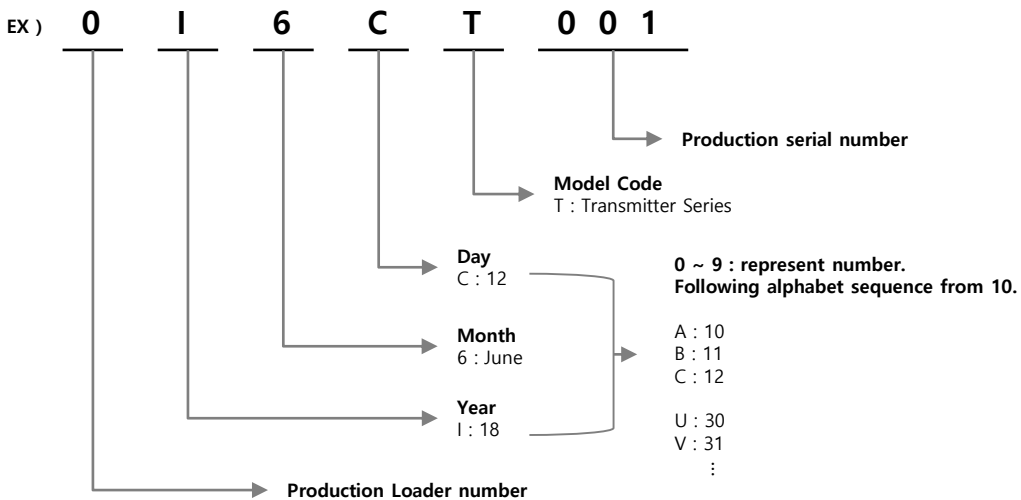

Figure 1. Serial Number Format



The "0I6CT001" is translated like below description.  
**The transmitter was first produced on June 18, 2018.**

This is an example to read a Firmware version of Air-Farm.

Example 3. Read Firmware Number

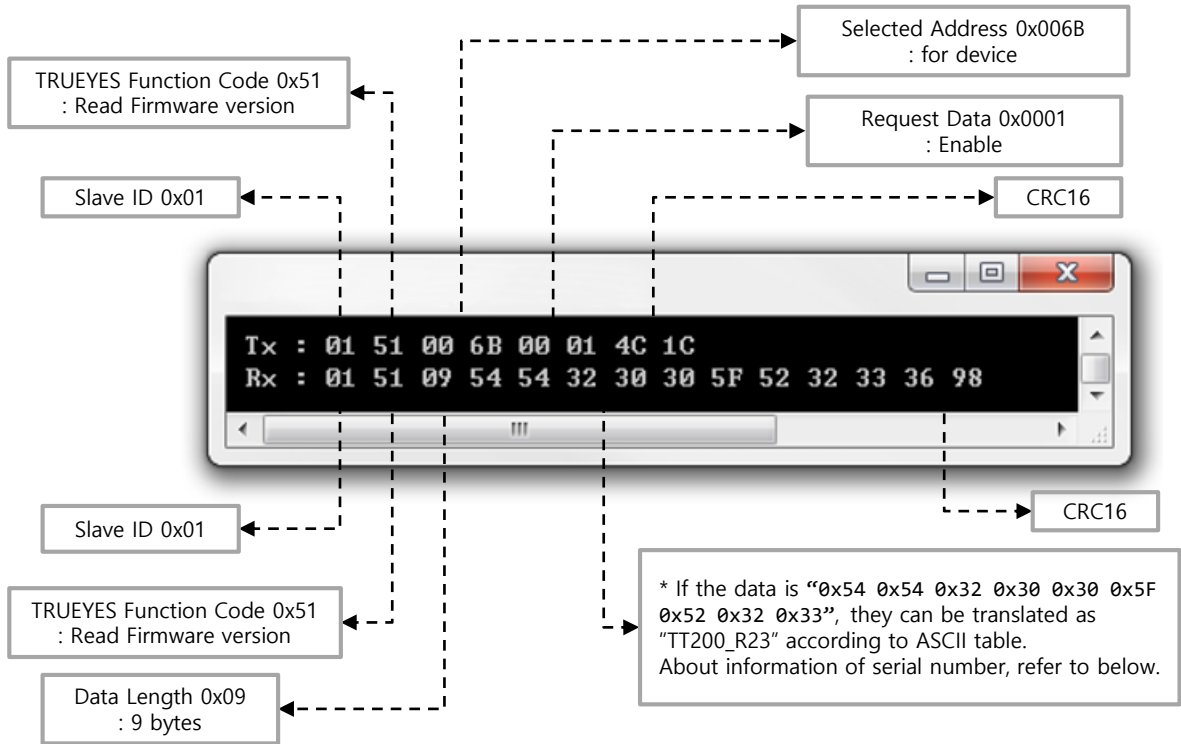

The firmware version of this transmitter be displayed as follows.  
The firmware version is different for each firmware version. The firmware version shown below is one example.

Figure 2. Firmware Version Format

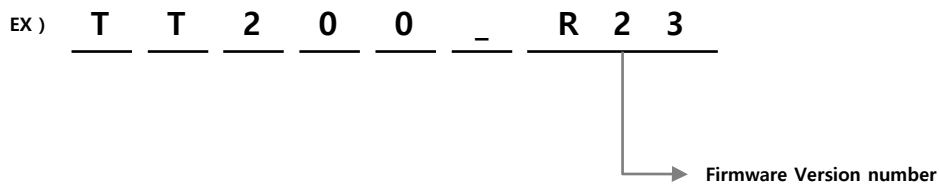

※ About manual calibration is on the TG100 Manual. Before start this command, Please Read the instructions

This is an example for request the manual calibration to CO2 sensor.

**Example 4. Request the manual calibration**

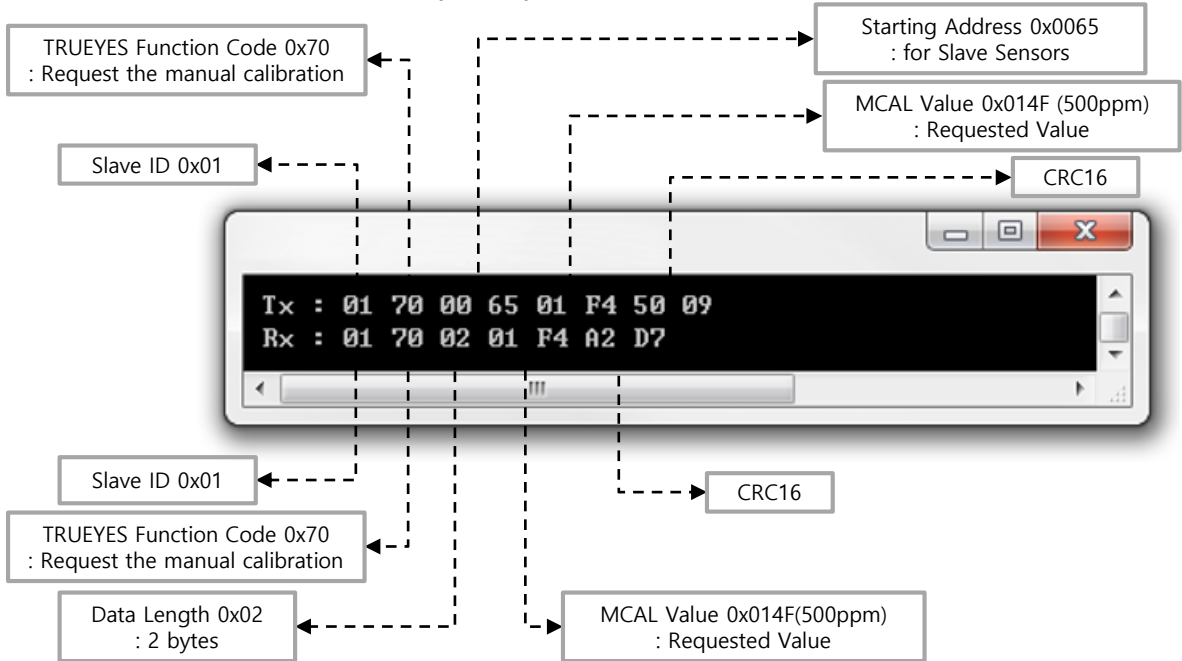

This is an example for Read manual calibration state to CO2 sensor.

**Example 5. Read Manual Calibration State**

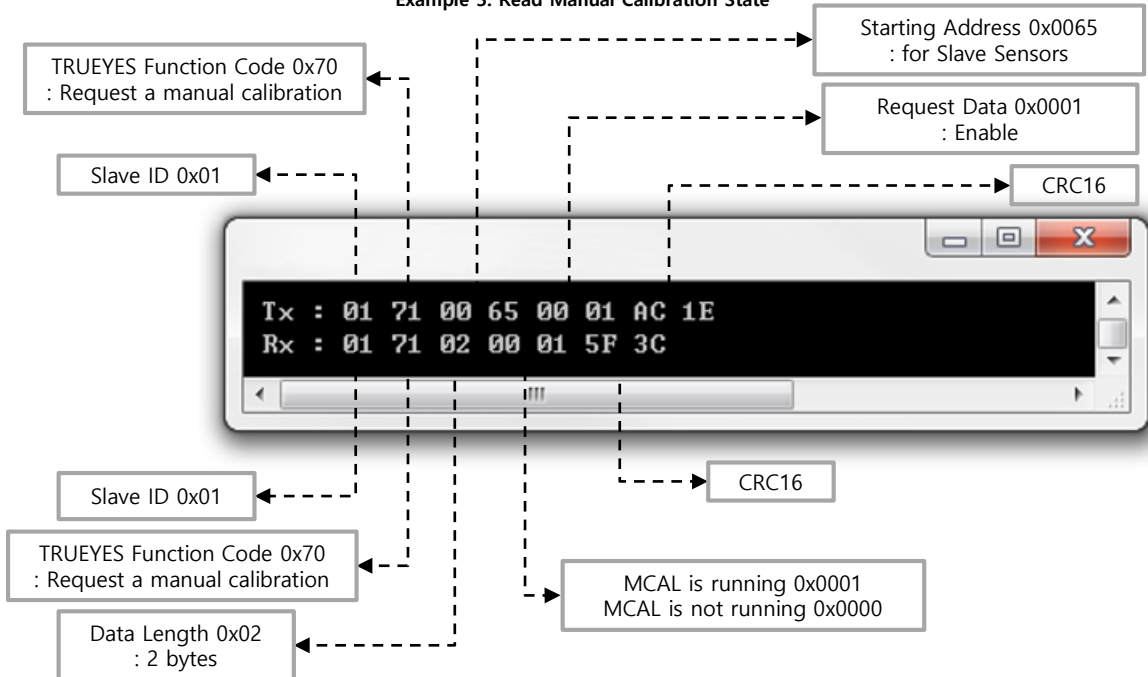



That is how the calculation of CRC (Cyclic Redundancy Check) is done. CRC16 is used in MODBUS RTU Mode. See figure 1, This figure is flow chart of CRC16 calculation and an example in C language for it.

Figure 3. Flow Chart

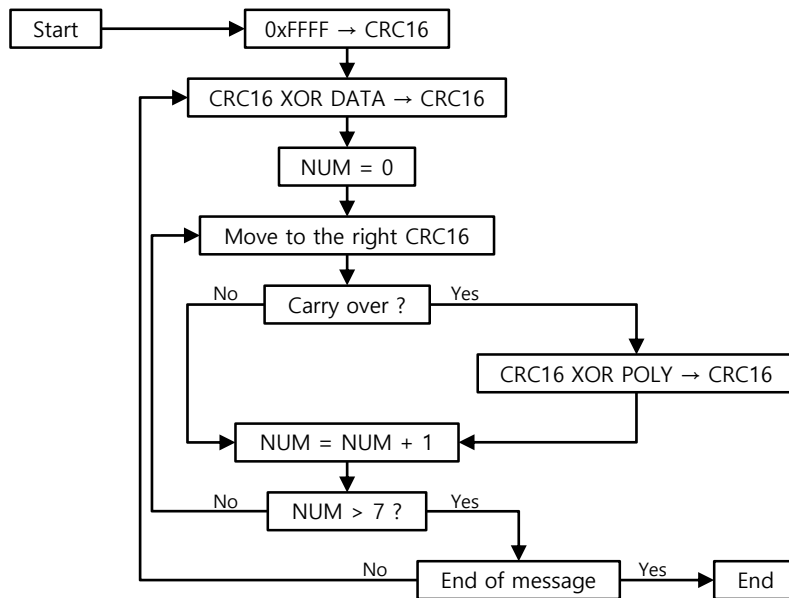

Example 6. CRC16 Calculation

```

#define POLYNORMALIAL 0xA001
unsigned short CRC16(unsigned char *puchmsg, int dataLength){
    int i;
    unsigned short crc, flag;
    crc = 0xFFFF;

    while(usDataLen--){
        crc ^= *puchmsg++;
        for (i=0; i<8; i++){
            flag = crc & 0x0001;
            crc >>= 1;
            if(flag){ crc ^= POLYNORMALIAL; }
        }
    }
    return crc;
}

void main(void){
    unsigned char data[8] = {0x01, 0x01, 0x00, 0x00, 0x00, 0x03, 0, 0};
    unsigned short crc16;
    crc16 = CRC16(data, 6);
    data[6] = (unsigned char)((crc16>>8) & 0x00FF);
    data[7] = (unsigned char)(crc16 & 0x00FF);
}
  
```

### Dimension

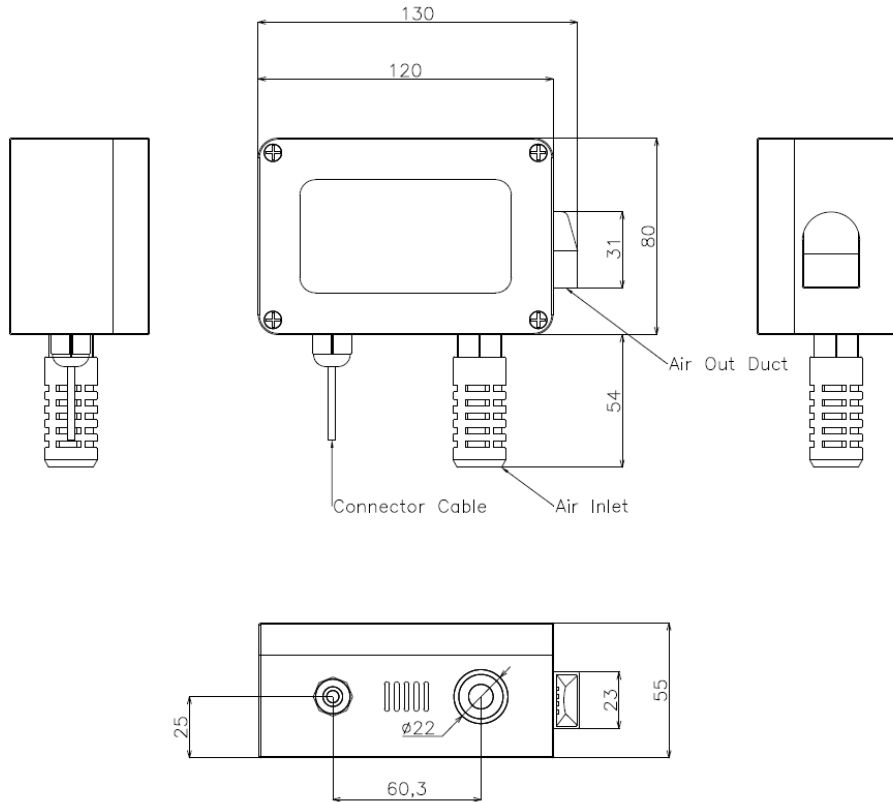

### Connector Pin Description

**Table 10. Pin Description**

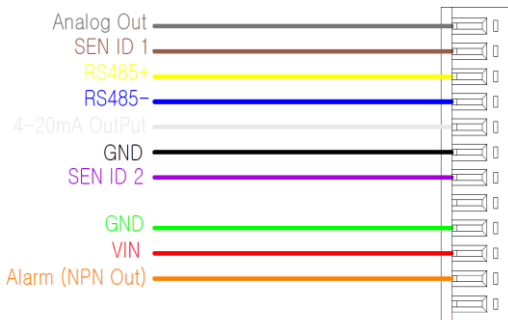

Pin Color.	Pin Assigned	Pin Color.	Pin Assigned
Grey	Analog Output	Black	GND
Brown	SEN_ID1	Purple	SEN_ID2
Yellow	RS485+	Green	GND
Blue	RS485-	Red	VIN
White	4-20mA Current Output	Orange	Alarm ( NPN Out )

**Figure 4. Connector by Color**

"SEN\_ID1" and "SEN\_ID2" are for detecting open circuit.

## Cautions on Usage

- Do not use this device for medical or safety purpose.  
This product is designed only for industrial and ordinary use.
  
- This product must abide by the operating and storage Temperature and humidity conditions. Do not leave or use the device for longtime in a highly damped place, in which humidity is over 95%RH.
  
- The standard test condition in which the product was tested is  $25^{\circ}\text{C}\pm 3^{\circ}\text{C}$ ,  $50\pm 30\%\text{RH}$ . Signal may vary slightly with environmental condition.
  
- Be careful while installation and using it, as it may cause serious damage to the sensor in case of, vibration or shock or falling on the hard surface.
  
- We do not guarantee the performance of this device in case of user installation, disassembling, assembling it at anybody's discretion. If installation and inspection is required, then, Please, contact our technicians.
  
- NDIR type CO<sub>2</sub> sensor is influenced by air pressure. It can be used without correction within 300m range, above sea level. However, the output value may vary by  $\pm 1.0\%$  / 100m height, above, 300m from sea level.
  
- Use when it is fixed, not, while it is in motion.

## Warranty Information

During this 1 year period, our liability hereunder is limited to the replacement of the products.

The warranty will become void, if the product is been damaged due to an accident, unreasonable use, negligence, tampering or other causes not arising from defects in material or workmanship and extends to the original consumer of the product only.

## Revision History

Revision	Description	Date	Owner
1.2	- Initial Release	2018-06-11	DH Jeong
1.3	<ul style="list-style-type: none"><li>- Added RS485 serial number, firmware number message.</li><li>- On Page 5, added TRUEYES Function Code Table.</li><li>- On Page 5, added Sensor Address Table of Slave (This Transmitter)</li><li>- Added serial number and firmware number I2C packet.</li><li>- Added how to read by Serial number and firmware number.</li><li>- Added how to read by Request a manual calibration.</li><li>- Added how to read by manual calibration state</li></ul>	2018-06-29	DH Jeong



A-1409, Gwangmyeong Techno Park, 60, Haan-ro, Gwangmyeong-si,  
Gyeonggi-do, 14322, South Korea

**Tel.** +82-2-2083-2377~8 **FAX.** +82-2-2083-2379

**E-mail.** [trueeyes@trueyes.co.kr](mailto:trueeyes@trueyes.co.kr) **Business Number.** 212-81-90254

<http://www.trueyes.co.kr>